

ASSEMBLY INSTRUCTION

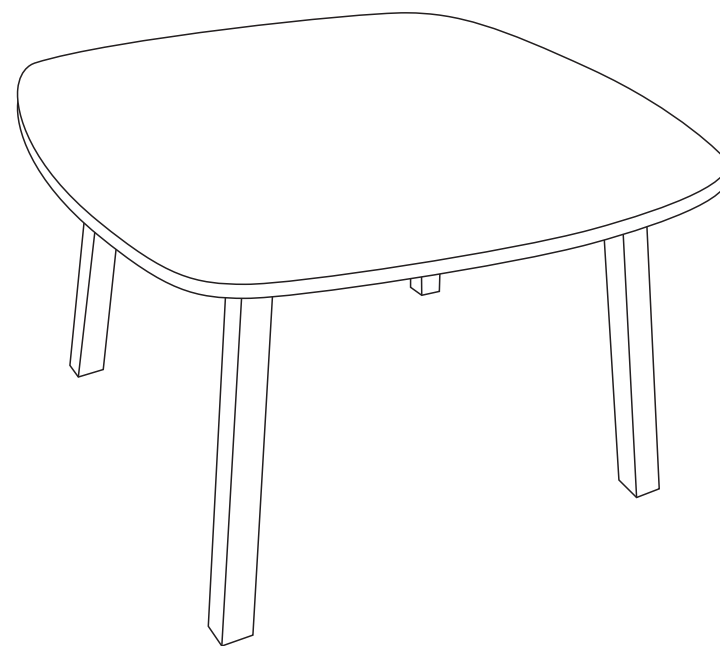

Ax1

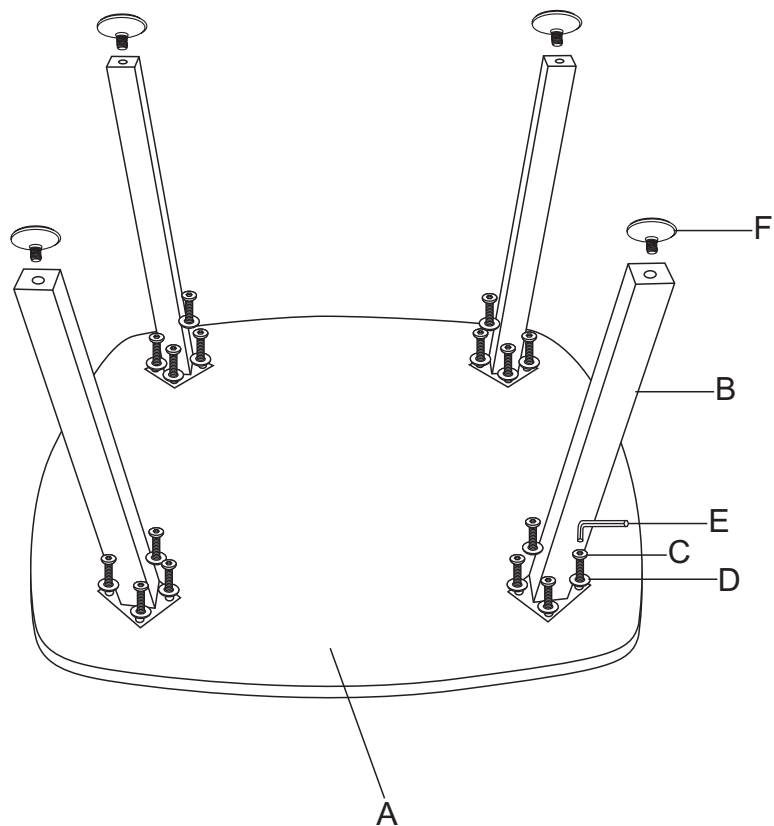

Bx4



Cx16



Dx16



Ex1



Fx4

